



14		
Q		
R		
AQ1		
AQ2		
AQ3		
AQ4		
S	Stopc onder toog	
T	Stopc onder eettoog 1	
U	Stopc onder eettoog 2	
V	Stopc kelder	
W		
A'	Reserve	G' -verlichting traphal --verlichting slk1 -verlichting slk2
B'	Ventilatie	H' stopc linnenkamer
C'	Stopc boven	I' Reserve
D'	Stopc living	J' stopc raam
E'	-Gemengd linnenkamer -licht verwarming	K' Verwarming
F'	-verlichting hall -verlichting living --verlichting 1eV	L' Badkamer
		M' reserve

Erkend Organisme  
ACA

Plaats van de elektrische installatie  
Bar Mirwaar  
Burgstraat 59  
9000 Gent

Installateur  
Pieter Verstraelen  
Palinghuizen 75  
be0536852438



p. 14/14  
Lijst Kringen  
3 x 400V + N ~ 50Hz

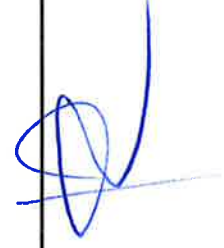

<p>14</p> <p>Q</p> <p>R</p> <p>AQ1</p> <p>AQ2</p> <p>AQ3</p> <p>AQ4</p> <p>S</p> <p>T</p> <p>U</p> <p>V</p> <p>W</p> <p>A'</p> <p>B'</p> <p>C'</p> <p>D'</p> <p>E'</p> <p>F'</p>	<p>-verlichting traphal</p> <p>--verlichting sik1</p> <p>-verlichting sik2</p> <p>stopc linnenkamer</p> <p>Reserve</p> <p>stopc raam</p> <p>Verwarming</p> <p>Badkamer</p> <p>reserve</p> <p>Stopc onder toog</p> <p>Stopc onder eettoog 1</p> <p>Stopc onder eettoog 2</p> <p>Stopc kelder</p> <p>Reserve</p> <p>Ventilatie</p> <p>Stopc boven</p> <p>Stopc living</p> <p>-Gemengd linnenkamer</p> <p>-licht verwarming</p> <p>-verlichting hall</p> <p>-verlichting living</p> <p>--verlichting 1eV</p>	<p><b>G'</b></p> <p><b>H'</b></p> <p><b>I'</b></p> <p><b>J'</b></p> <p><b>K'</b></p> <p><b>L'</b></p> <p><b>M'</b></p> <p>Plaats van de elektrische installatie Bar Mirvaer Burgstraat 59 9000 Gent</p> <p>Installateur Pieter Verstraelen Palinghuizen 75 be0536852438</p> <p>p. 14/14 Lijst Kringen 3 x 400V + N ~ 50Hz</p> 
<p>Erkend Organisme ACA</p>		<p>Schema's getekend door: E-Maze B.V.B.A. - BTW BE 0881.880.250</p>



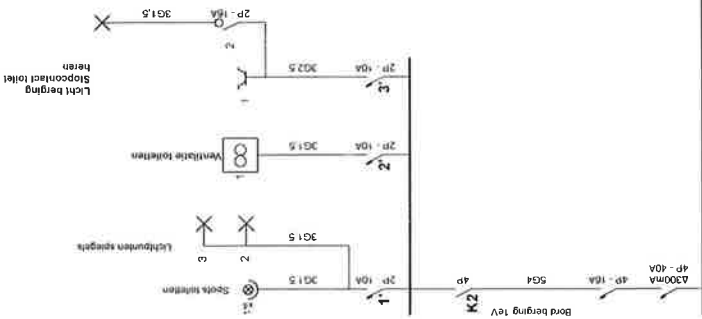

Erkend Organisme  
 ACA Meensesteenweg 338 - 8800 Roeselare  
 BTW BE 0811.407.868  
 Tel. 03120 00 02 - Fax 03120 00 03  
 info@accowzw.be - www.acco.be

10p  
 2018

Plaats van de elektrische installatie  
 Bar Mirwaar  
 Burgstraat 59  
 9000 Gent

Installateur  
 Pieter Verstraelen  
 Palinghuizen 75  
 be0536852438

*[Handwritten signature]*

P. 2/14  
 Eendraadschema  
 3 x 400V + N ~ 50Hz





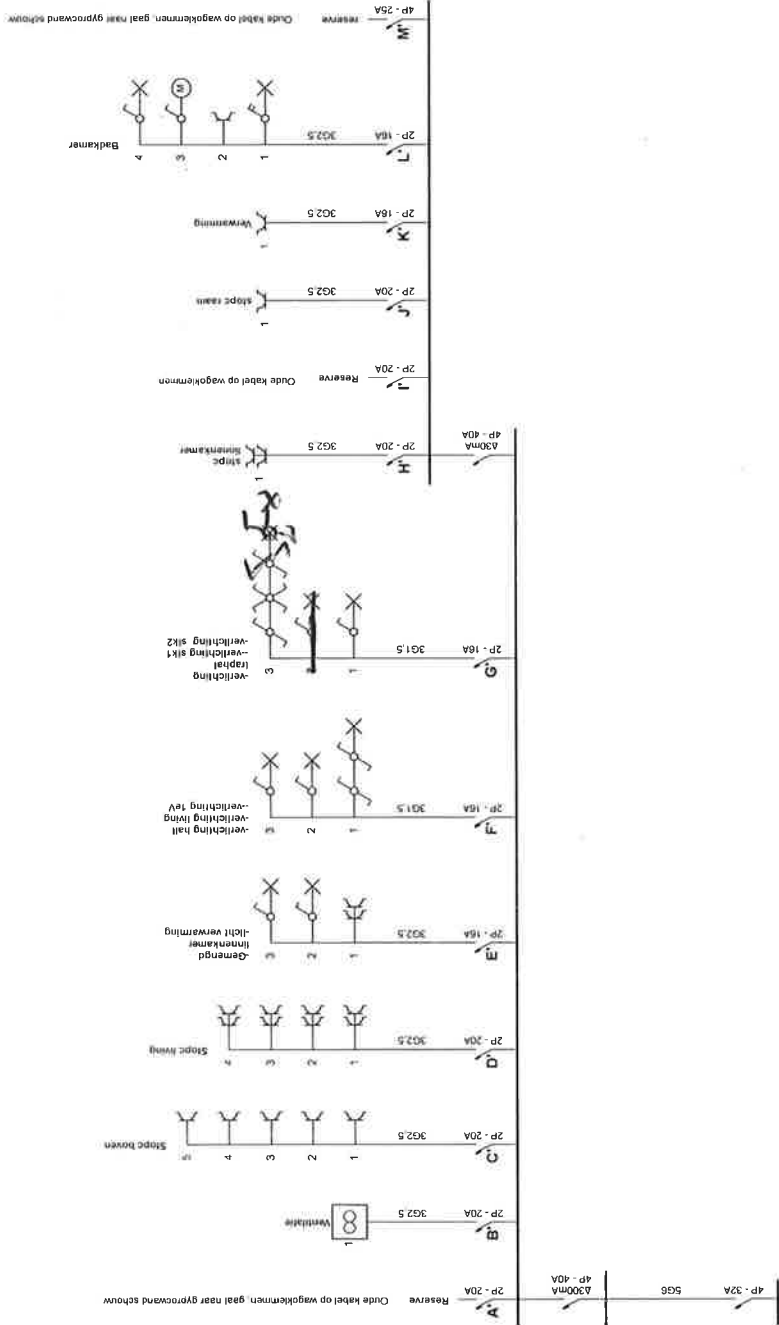

**Erkend Organisme**  
 vzw - Erkend Controle Organisme  
 A.C.A.  
 Maensesteenweg 338 - 8800 Rosseleire  
 BTW BE 0811.407.869  
 Tel 051/20 07 02 - Fax 051/20 10 02  
 info@accvzw.be - www.accvzw.be

*25-01-2018*  
*109*

**Plaats van de elektrische installatie**  
 Bar Minwaar  
 Burgstraat 59  
 9000 Gent

**Installateur**  
 Pieter Verstraelen  
 Palinghuizen 75  
 be0536852438

*[Handwritten signature]*

**p. 5/14**  
**Eendraadschema**  
 3 x 400V + N ~ 50Hz

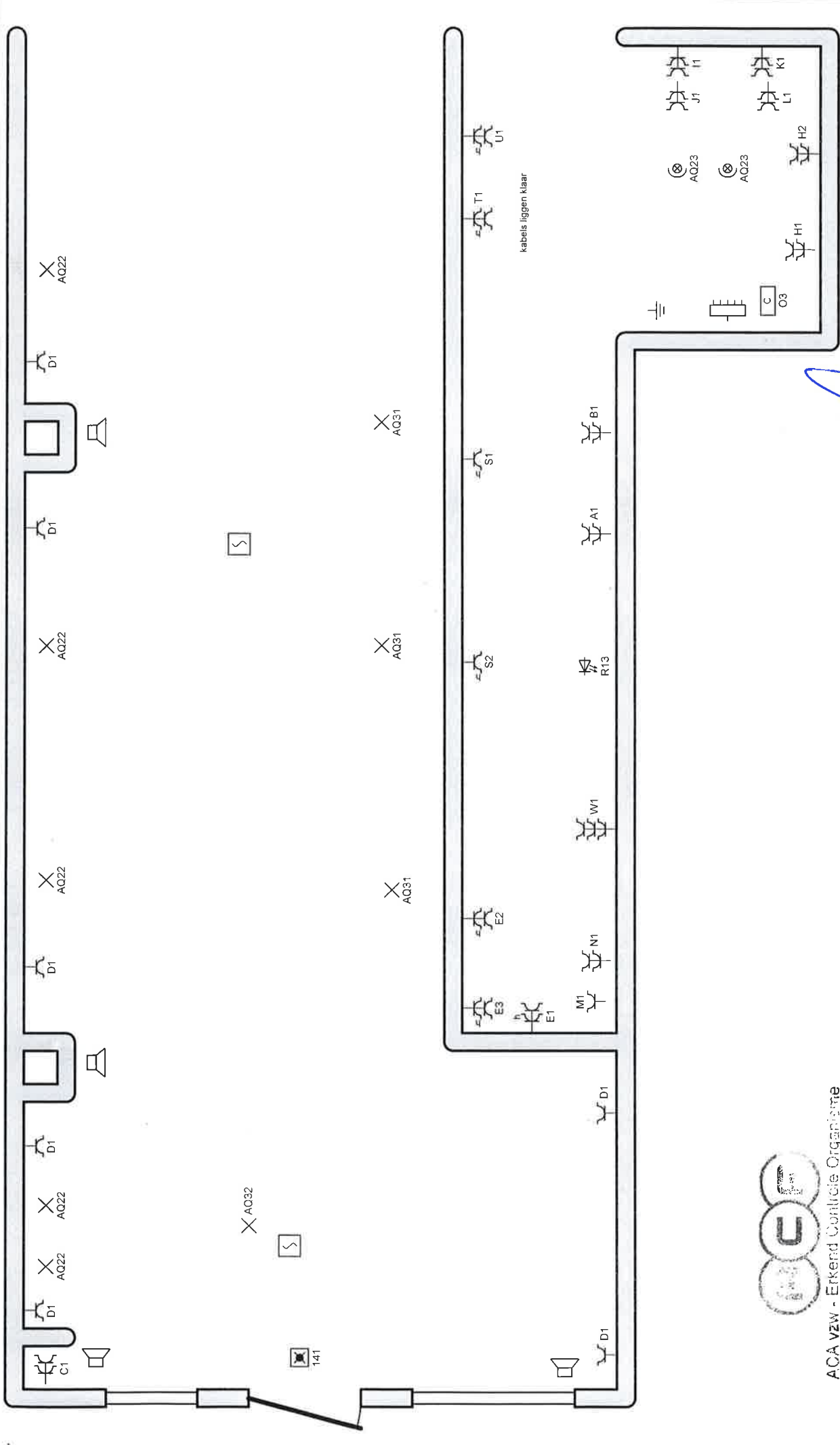

ACA VZW - Erkend Controle Organisme

Meersselenweg 500 - Roeselare  
 Erkend Organisme BTW BE081 407 869  
 Tel. 051/20 00 02 - Fax 051/20 10 02  
 info@acavzw.be - www.acavzw.be

*189*  
*25.01.2018*

Plaats van de elektrische installatie  
 Bar Mirwaar  
 Burgstraat 59  
 9000 Gent

Installateur  
 Pieter Verstraelen  
 Palinghuizen 75  
 be0536852438

p. 6/14  
 Situatieschema

3 x 400V + N ~ 50Hz



Aftakdoos uitbreiding verlichting

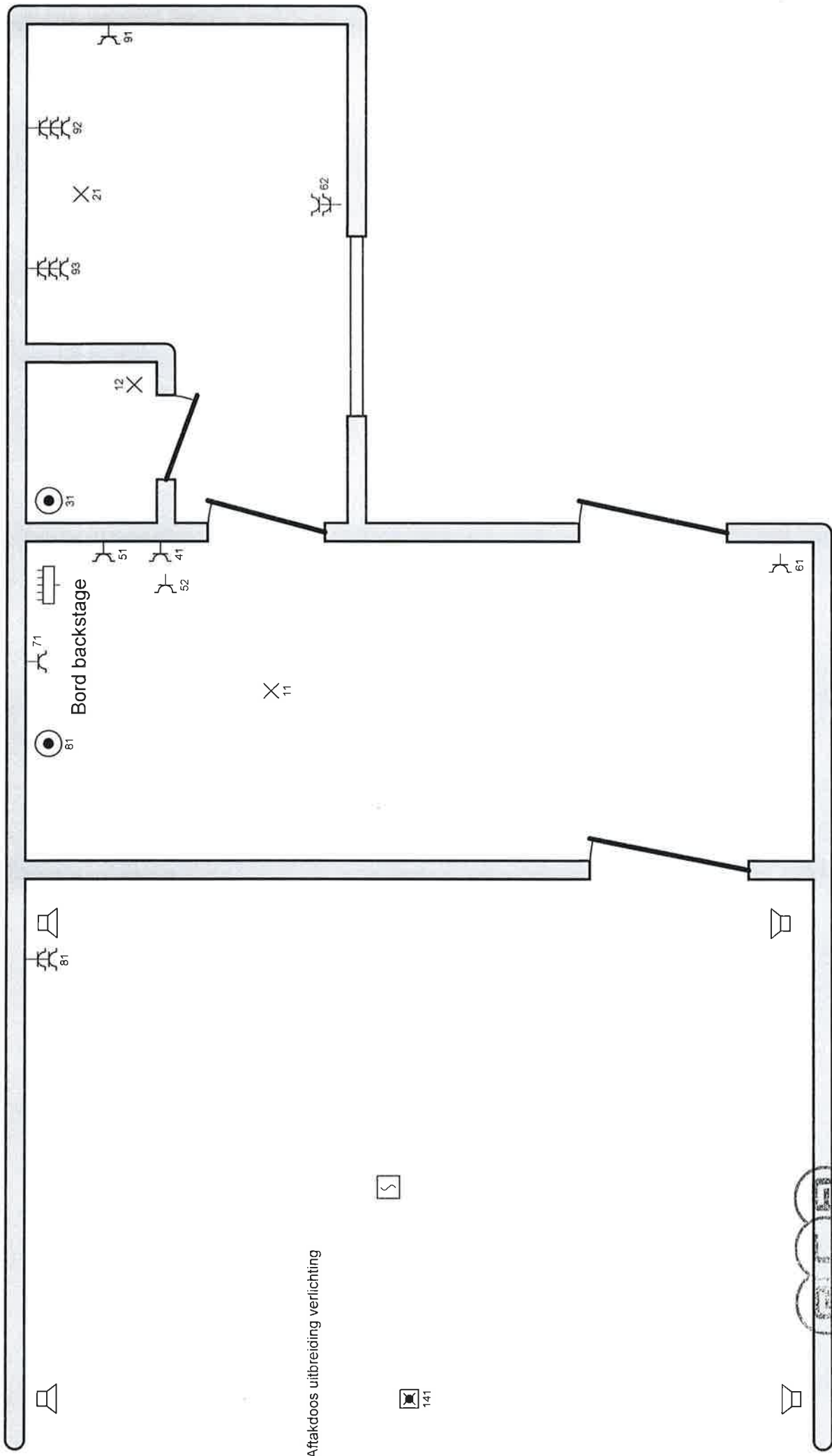
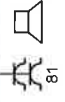

Erkend Organisme w - Bureau Controle Organisme  
ACA Meensesteenweg 338 8800 Roeselare

BTW BE 0311437839  
Tel. 051200002 Fax 051201002  
www.acacontrole.be

*10/03/2018*  
*25-01-2018*

Plaats van de elektrische installatie

Bar Mirwaar  
Burgstraat 59  
9000 Gent

Installateur

Pieter Verstraelen  
Palinghuizen 75  
be0536852438

p. 8/14  
Situatieschema

3 x 400V + N ~ 50HZ



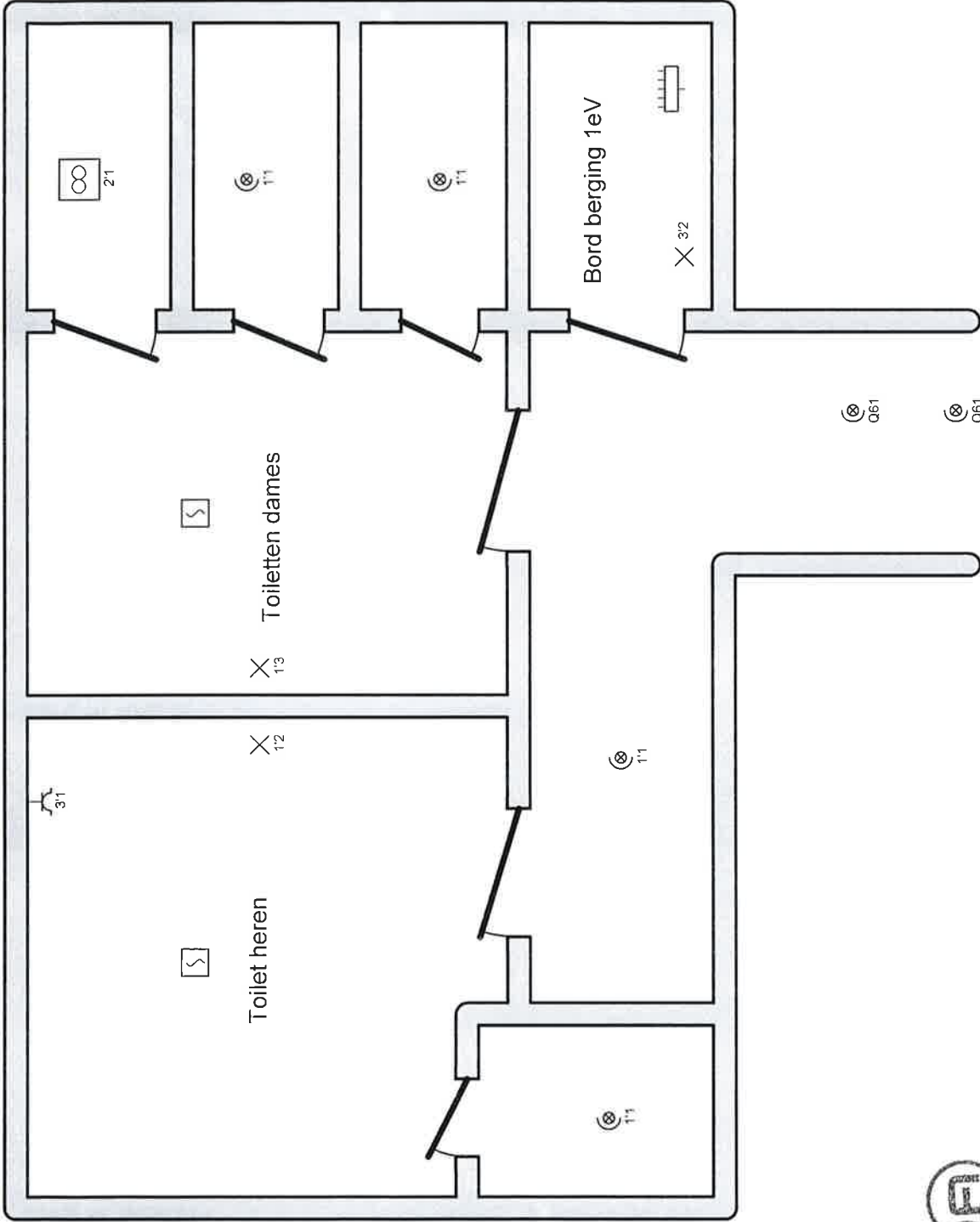

Erkend Organisme

ACA - Medische steenwaa 339 - 3000 Roeselare

BTW BE 0311407369

Tel: 05120 2202 - Fax: 05120 10 02

www.acavzw.be

*rep 17-01-2018*

Plaats van de elektrische installatie

Bar Mirwaar

Burgstraat 59

9000 Gent

Installateur

Pieter Verstraelen

Palinghuizen 75

be0536652438

p. 10/14

Situatieschema

3 x 400V + N ~ 50Hz

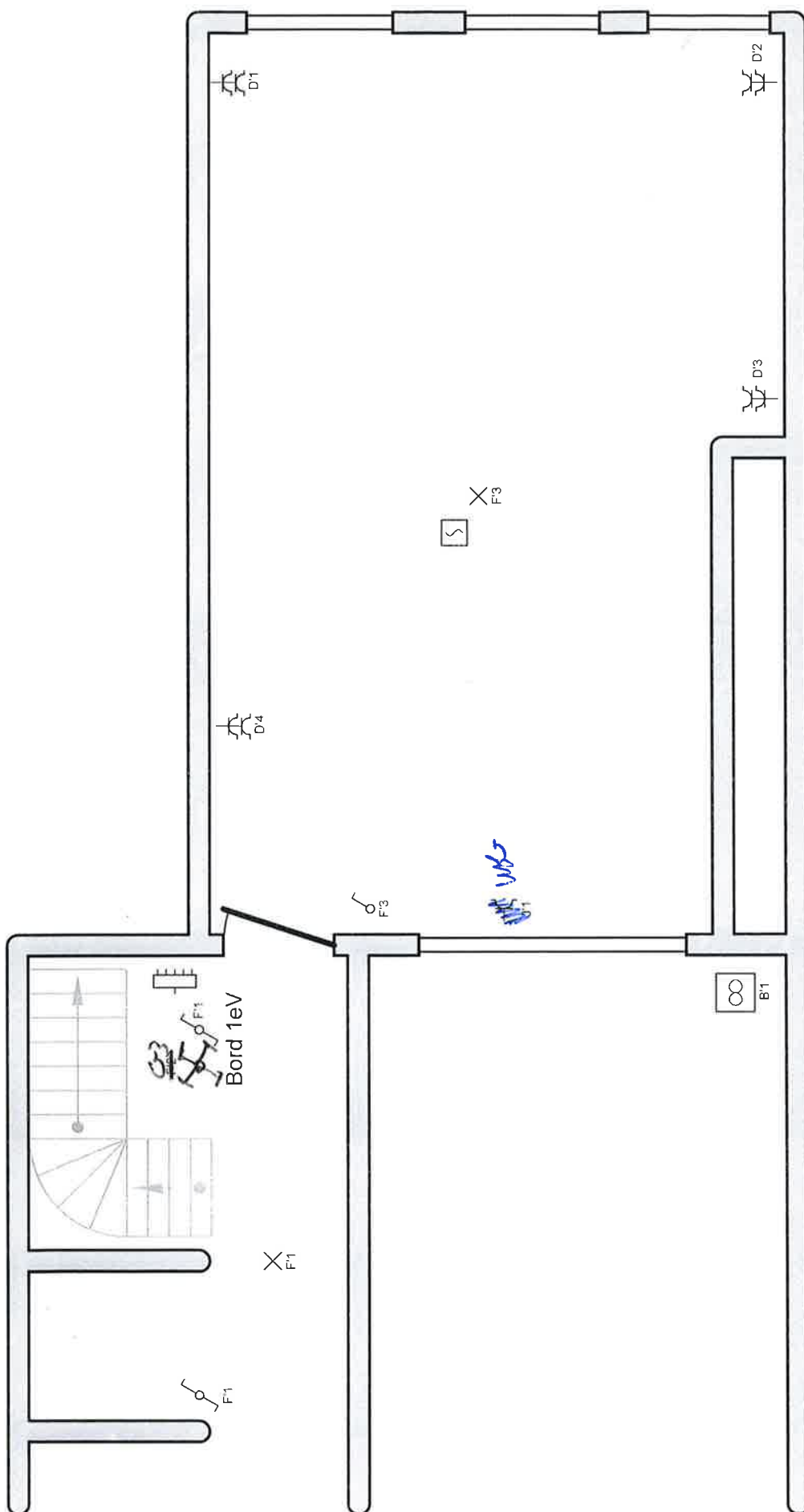

ACA vzw - Erkend Controle Organisme

Mensesteenweg 33 - 8800 Aalst  
 BTW BE 0211407869  
 Tel. 051/20/00 02 - Fax 051/20 10 02  
 info@acavzw.be - www.acavzw.be

19  
 25.01 2018

Erkend Organisme  
 ACA

Plaats van de elektrische installatie  
 Bar Mirwaar  
 Burgstraat 59  
 9000 Gent

Installateur  
 Pieter Verstraelen  
 Palinghuizen 75  
 be0536852438

*[Handwritten signature]*

p. 11/14  
 Situatieschema

3 x 400V + N ~ 50Hz

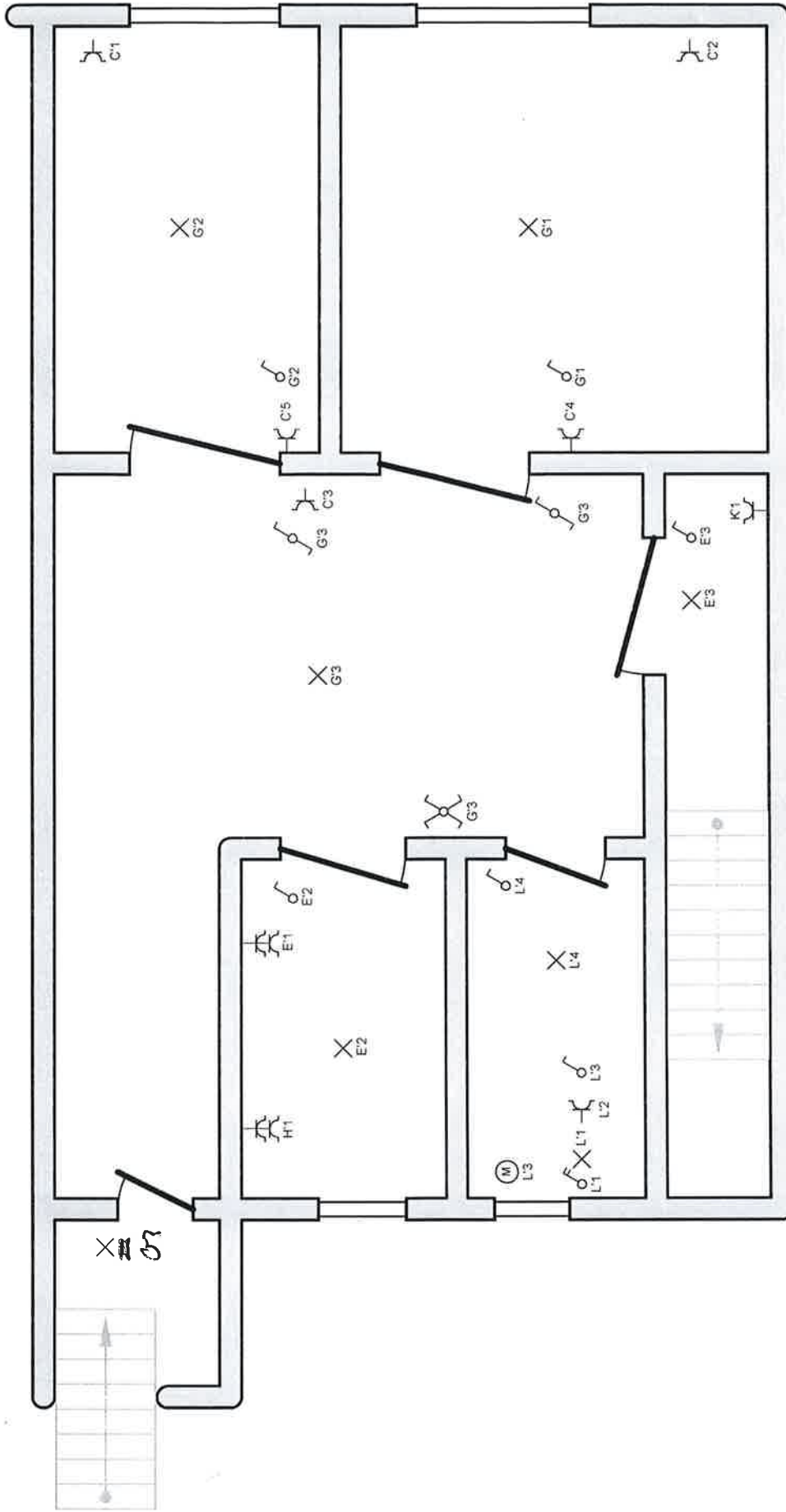

**p. 12/14**  
**Situatieschema**  
 3 x 400V + N ~ 50Hz

**Installateur**  
 Pieter Verstraelen  
 Palinghuizen 75  
 be0536852438

**Plaats van de elektrische installatie**  
 Bar Minwaar  
 Burgstraat 59  
 9000 Gent

**Erkend Organisme**  
 ACA  
 Roeselare  
 Tel: 051/20 0007 - Fax 051/20 10 02  
 www.aca-zw.be

*10/11 25.01.2018*

